

“the essence of formulating strategy is relating a company to its environment”.



TPC

PRECAST CONCRETE SPECIALIST

T.P.C PRESTRESSED CONCRETE CO.,LTD.



PRECAST CONCRETE SPECIALIST



CONTENT LIST

PAGE

A COMPANY OVERVIEW

1

B MANAGEMENT TEAM

2

C PROFESSIONAL SERVICES

2

D FINANCIAL AFFAIRS

3

E SAFETY

4

F PROJECTS

5-8

G PRODUCT CATALOG

1. PRESTRESSED CONCRETE PILE

9-10

2. PRESTRESSED CONCRETE SPUN PILE

11-12

3. PRESTRESSED CONCRETE SHEET PILE

13-14

4. PRESTRESSED CORRUGATED CONCRETE SHEET PILE

15-16

5. PRESTRESSED CONCRETE SOLID PLANK GIRDER

17

6. PRESTRESSED CONCRETE I-GIRDER

18

7. PRESTRESSED CONCRETE BOX GIRDER

19

8. PRESTRESSED CONCRETE PEDESTRAIN BRIDGE T GIRDER

20

9. PRESTRESSED CONCRETE PEDESTRAIN BRIDGE BOX GIRDER

21

10. PRECAST WHEEL STOP

22

11. PRECAST CONCRETE FACADE

23-24

12. GLASS REINFORCED CONCRETE

25-26

13. TPC KOOL WALL

27-28

14. PRECAST CONCRETE FORMWORK

29-30

15. PRECAST CONCRETE FENCE

31-32

COMPANY OVERVIEW

BACKGROUND

Since our group is incorporated in 1996, we emerged as one of the fastest growing company in Thailand with its specializing in the field of civil engineering works. We become an established and recognized company in all sectors of the building industry projects under the well-guidance of our management team.

OUR VISION

To Build Better Prosperous Society in which Company's Sustainable Development and Well Contribute to Community and Develop Better Total Precast concrete Systems.

OUR MISSION

According to Thailand Government's policy of firm economic vision, we will improve and create more job opportunities for all people and will build strong brand of our company in local region.

SPECIALIZATION

We are currently expert provider in engineering fields in such as precast concrete industry, urban planning, infrastructure development, building & bridge constructions and renovation works.

QUALITY

We are dedicated to ensure that all of our performance are to maintain the best possible quality of standard:

In accordance with

- Contracts specifications and designs.
- Rules and regulations issued by Federal and local government.
- Satisfaction of public & private individual needs.
- Hold the most priority of policy "Safety First "on any conditions.
- In compliance with Building codes and relevant codes to meet the required quality.

KEY PERSONNEL & TEAMS

In implementing the constructional projects, not only experiences but also management skill is essential one. Management team is under Mr. PAIBOON PANICHNANTHO, managing director and Mr. UTHAI BUNSOMJIT, deputy managing director with the total permanent staffs more than 200 persons working in each departments such as factory department, service department, construction department and office department.



MANAGEMENT TEAM

MR.PAIBOON PANICHNANTHO

Managing director & founder

B.Sc (Civil Engineering), Prince of Songkla University

Starting the career as Structural engineer as public service in Royal Irrigation Department (RID), Thailand.

Gaining prosperous experience about precast concrete technology by excelling through many piling work and precast concrete industries.

Finally set up my own company to be brightened ahead and bringing positive value to its society.



MR.UTHAI BUNSOMJIT

Deputy managing director 1

B.Sc (Civil Engineering), Prince of Songkla University

Working dedicatedly in the field of management as start from my beginning of career.

I ever enthusiast to channel all of my well-gained experiences and knowledge to apply in managing and developing the financial aspects of my company.



MR.ARTHIT KUPAVAT

Deputy managing director 2

MASTER OF BUSINESS ADMINISTRATION, SAINT LOUIS UNIVERSITY, USA.

Assist and support for company trading and one of core pusher for business related aspects and public relations development.



PROFESSIONAL SERVICES

Overview

We provide wide range of products and services related precast concrete since very early stage of precast concrete industry development in Thailand.

Not only supplying but also installation and even fabrication of the products are what we TPC has been serving in order to satisfy various requirements of the clients.

1 . Design

2 . Construction

building, warehouse & factory
road, minor bridge, overpass & interchange
retaining wall & flood protection wall.

3 . Concrete products & engineering services

- Prestressed concrete pile
- Prestressed concrete spun pile
- Prestressed concrete sheet pile
- Prestressed concrete girder
- Post-tensioning girder
- Precast wall/parapet/facade
- Precast column/beam
- Precast elements for housing, building & factory
- Glass reinforced concrete (GRC)
- Other precast concrete products & other concrete service

FINANCIAL AFFAIRS

REGISTERED CAPITAL : MIL. USD 3.20 (BAHT 100,000,000)
MAXIMUM ANNUAL WORK LOAD : MIL. USD 32 (BAHT 1,000,000,000)

KASIKORN BANK PUBLIC COMPANY LIMITED
Watcharapol Branch Tel. 02-509-0018

BANGKOK BANK PUBLIC COMPANY LIMITED
PTT Ramintra road Branch Tel. 02-362-4935

KRUNGSRI BANK PUBLIC COMPANY LIMITED
Ladprao 102 Branch Tel. 02-539-4510-1

SIAM COMMERCIAL BANK PUBLIC COMPANY LIMITED
Ramintra 4,5 Branch Tel. 02-519-4540-8



SAFETY



PROJECTS

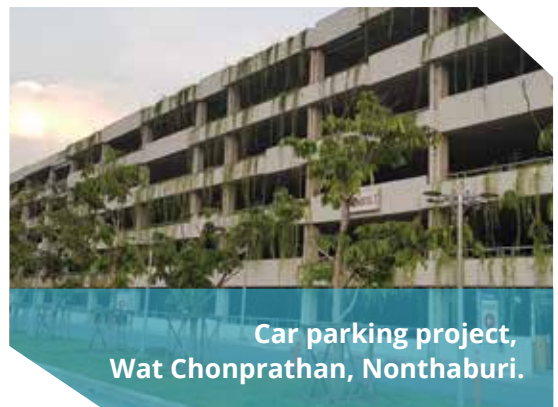



**Bank protection wall project,
Property Perfect PLC, Pathumthani.**



**Landscape Improvement project,
Wat Chonprathan, Nonthaburi.**



**Bank protection wall project,
Khannakorn reservoir, Khonkhan.**



**Luxury apartments project,
The Rich, Samuthprakarn.**



**Flood protection wall project,
Kraburi, Ranong.**



**Community Hall project,
Samuthprakarn.**



**Waterfront pavilion project,
Wat Bot, Samkhor, Pathumthani.**



**Bank protection wall at
Klong Lat Pho Floodgate project,
Samuthprakarn**



Precast Concrete Facade,
APL Sindhorn, Bangkok.



Precast Concrete Facade,
Asian Stanley International,
Pathumthani



Precast Concrete Facade,
LPV Sindhorn Langsuan Village,
Bangkok.



Precast Concrete Facade & Gutter,
Canon Prachinburi (Thailand),
Prachinburi.



Precast Concrete Facade,
Terra Data Center,
Bangkok.



Precast Concrete Facade &
Retaining Wall,
Tatsuno, Pathumthani.



Precast Concrete Facade, AMEC,
Amata-nakorn Industrial Park,
Chonburi.



Precast Concrete Facade,
ICONSIAM, Bangkok.



Precast Concrete Skeletons,
230/500 KV,
Sub Station, Ayutthaya.



Precast Concrete Skeletons
& GRC Facade, Wat Chonprathan,
Nonthaburi.



Precast Concrete Column,
IKEA Bangyai, Nonthaburi.



Precast solid plank girder,
PEPSICO THAILAND, Saraburi.



Precast Concrete Beam,
Solaria Hotel, Bangkok.



Precast Concrete Box Girder,
Floating railways,
Pasak Dam, Lopburi.



Precast Concrete Skeletons,
Thaveepol product factory,
Pakkret, Nonthaburi.



Build up Steel Girder,
Donmuang International
Airport Elevated Bridge,
Bangkok.

1. PRESTRESSED CONCRETE PILE



Foundation is the main part of structure in construction work. The strong foundation relates to good quality pile. TPC prestressed concrete pile is produced under quality control and up-to-date machine. There are many types and sections of piles to be selected for using in the various condition. TPC pile is followed Thailand Industrial Standard TIS 396-2549.

To select the type, cross-sectional area and length of pile must be considered to the bending moment required. For the special case, TPC can propose the alternative design to clients.

CONCRETE

- Minimum ultimate compressive strength shall not less than 350 ksc. cylinder at 28 days.
- Minimum transfer strength shall not less than 245 ksc cylinder.
- High early strength Portland cement is used and cement content shall not less than 350 kgs. per cubic metre.

PC. WIRE



- PC. Wire \varnothing 4,5 mm. and PC.7-Wire strand \varnothing 3/8" , \varnothing 1/2" (Grade 270 k) are used and minimum breaking strength is about 16,500-18,500 ksc.
- Minimum force transfer to concrete shall not be less than 70% of breaking strength.

REMARKS

- Allowable safe load depends on soil condition.

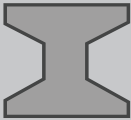

STANDARD SPECIFICATION

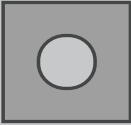
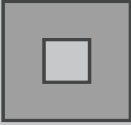
SECTION	SIZE OF PILE (m.xm.)	PERIMETER (cm.)	SECTIONAL AREA (cm. ²)	UNIT WEIGHT (kg/m.)	MAX.LENGTH (m.)	SAFE LOAD (tons)
	0.18 X 0.18	80	204	49	14	8
	0.22 X 0.22	118	337	81	22	20
	0.26 X 0.26	A 126	480	110	24	30-35
		B126	500	120	24	30-35
	0.30 X 0.30	A150	600	144	24	35-40
		B 153	660	158	24	40-45
	0.35 X 0.35	A174	781	187	25	50-55
		B 170	880	211	25	55-60
0.40 X 0.40	A202	1028	247	25	60-70	
	B197	1240	298	25	70-80	
0.525 X 0.525	244	2050	492	28	80-120	
	0.18 X 0.18	72	324	78	14	15-25
	0.22 X 0.22	88	484	116	21	25-30
	0.25 X 0.25	100	625	150	22	30-40
	0.30 X 0.30	120	900	216	24	40-50
	0.35 X 0.35	140	1225	294	25	50-60
	0.40 X 0.40	160	1600	384	25	60-80
	0.45 X 0.45	180	2025	486	28	80-120
	0.525 X 0.525	210	2756	662	28	100 UP
	0.40 X 0.40	160	1268	309	28	40-90
	0.45 X 0.45	180	1534	368	28	50-100
	0.525 X 0.525	210	2049	432	30	90-120
	0.65 X 0.65	260	2544	611	30	110-150

REMARKS : Safe load depends on soil condition.



2. PRESTRESSED CONCRETE SPUN PILE



The TPC prestressed spun concrete pile products are followed Thailand Industrial Standard (TIS 398-2537), which is comparable to the other international standards. TPC'spun piles have been accepted in many large-scale projects, not only of the government and private sectors, but also foreign companies.

Regardless of the economic crisis, TPC still conserves its business aim to systematically and consistency improves the quality of its products and services. For the benefit of environment and natural resources, advance technologies are continuously applied to its production process and to all company activities.

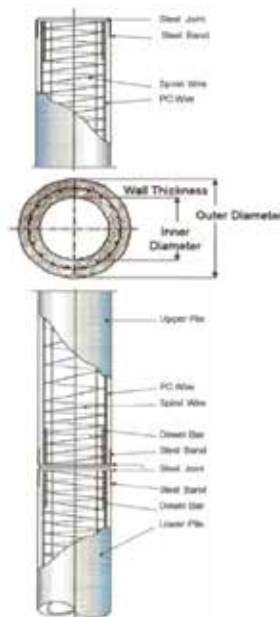

1. SPUN PILE
STANDARD DETAIL

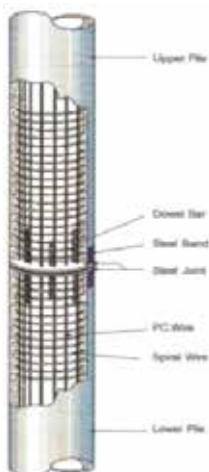

2. UPPER AND LOWER
PILE JOINT DETAIL

STANDARD SPECIFICATION

CONCRETE

- Coarse aggregate and fine aggregate shall be conform to AASHTO M80 and M6 respectively.
- Cement shall be conform to TIS 15-2514 (ASTM C 150-63) type 3.
- Ultimate compressive strength of standard cylinder is not less than 250 ksc. at transfer stage and 500 ksc. at service stage 28 days age.
- Covering to spiral reinforcement shall be not less than 25 mm.

PRESTRESSING STEEL

- Pc wire shall be conform to TIS 95-2540

REINFORCING STEEL

- Vertical reinforcement shall be grade SR24 and SD30 in accordance with TIS 20-2527 and TIS 24-2536 for round bar, deformed bar respectively.
- Spiral reinforcement shall be conform to TIS.194-2535.

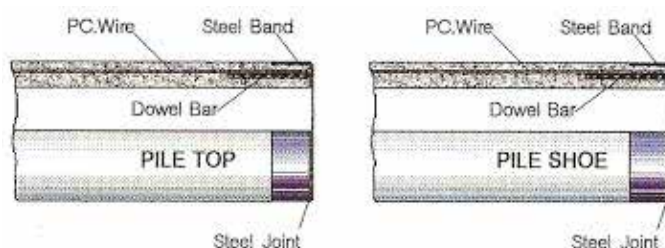

3. TOP - SHOE DETAIL

STANDARD SPECIFICATION

PILE					TYPE OF PILE	PC.WIRE		SPIRAL Diameter (mm.)	PRESTRESS		MOMENT CAPACITY			AXIAL LOAD	
Diameter (mm.)	Max Length (m.)	Wall Thickness (mm.)	Section Area (sq.cm.)	Moment of Inertia (cm.4)		Diameter (mm.)	No. of Wire (pcs.)		Initial Force (Tons)	Effective Prestress (kg./cm ²)	Ultimate Resisting (kg.-m.)	Allowable Bending (kg.-m.)	Allowable Under Handling (kg.-m.)	Nominal Max.Load (Tons)	Concentric Load (Tons)
250	13	55	337	17,289	TIS	5	7	3.2	17	42	2,139	949	1,072	106	41
300	15	60	452	34,546	TIS	5	10	3.2	25	44	3,605	1,616	1,822	142	54
350	15	65	582	62,763	TPC	5	13	3.2	32	49	5,560	2,539	2,857	182	70
	16	65	582	62,052	TIS	5	13	3.2	32	44	5,468	2,504	2,821	183	70
400	15	75	766	106,299	TPC	7	8	3.2	37	38	7,118	3,457	3,932	243	93
	16	75	766	106,299	TPC	9	8	4.0	53	52	10,382	4,203	4,679	236	90
	17	75	766	106,299	TIS	7	9	3.2	40	41	7,772	3,611	4,086	241	93
450	18	80	930	166,274	TIS	7	11	3.2	49	42	10,687	5,039	5,700	293	112
500	17	90	1,159	254,870	TPC	9	13	4.0	87	56	21,089	8,400	9,312	355	136
	18	90	1,159	254,870	TIS	7	13	3.2	58	41	14,033	6,888	7,780	366	140
600	20	100	1,571	509,600	TIS	7	17	3.2	80	40	23,317	11,389	12,908	496	190
	26	100	1,571	509,600	TPC	9	18	4.0	117	55	35,040	13,849	15,368	482	184
700	20	110	2,038	916,378	TIS	7	15	4.0	105	41	35,656	17,595	19,937	643	246
	26	100	1,885	870,240	TPC	9	33	6.0	220	80	74,948	26,413	28,637	551	208
800	25	120	2,564	1,525,150	TPC	7	38	6.0	170	51	67,622	29,616	33,026	793	303
	25	120	2,564	1,525,150	TPC	9	32	6.0	208	59	83,059	32,659	36,069	781	298
	25	120	2,564	1,525,150	TIS	9	19	6.0	133	41	51,620	25,782	29,026	809	310
1,000	15	140	3,782	3,583,181	TPC	9	36	4.0	234	47	116,802	52,711	59,121	1,180	451
	15	140	3,782	3,583,181	TIS	9	36	4.0	240	49	116,802	53,886	60,296	1,176	450
1,200	11	150	4,948	6,945,750	TPC	9	42	4.0	273	42	163,522	79,968	90,323	1,556	596
	12	150	4,948	6,945,750	TIS	9	38	4.0	253	40	147,949	77,326	87,680	1,563	599



3 . PRESTRESSED CONCRETE SHEET PILE



TPC prestressed concrete sheet pile is produced under quality control and up-to-date machine. All processes of the production are strongly concentrated by the engineers and supervisors. Our products are wellknown used for the permanent and also temporary retaining wall. Our innovative design is more suitable, safe, and economy when compare with general steel sheet pile. TPC sheet piles can be designed for all construction cases and the construction sequence required.

To select the type, cross-sectional area, length, the bending moment and the shear force, TPC sheet pile must be designed and calculated by only the specialized engineer. The design and method of construction must be considered and suggested to the contractors. Also the method of construction is strictly controlled by the civil engineer at site.



STANDARD SPECIFICATION



CONCRETE

- Minimum ultimate compressive strength shall not less than 350 ksc. cylinder at 28 days.
- Minimum transfer strength shall not less than 245 ksc. cylinder.
- High early strength Portland cement is used and cement content shall not less than 350 kgs. per cubic metre.

PC. WIRE

- Pc wire \varnothing 4,5 mm. are used and minimum breaking strength is about 16,500-18,500 ksc.
- Minimum force transfer to concrete shall not be less than 70% of breaking strength.

REMARKS

- Allowable bending moment and shear force depend on soil condition and external surcharge load.

SECTION	CODE	SIZE OF PILE (mm.x mm.)	PERIMETER (mm.)	SECTION AREA (mm ²)	MOMENT INERTIA (cm ⁴)	UNIT WEIGHT (kg/m)	MAX.LENGTH (m.)	MAX. MOMENT (kg-m./pcs)
	LHP 300	300x300	1,200	35,300	56,313	85	12.00	1,500
	SHP 200	200X500	1,450	100,000	33,333	240	18.00	5,500
	SHP 250	250X500	1,550	125,000	65,104	300	20.00	7,500
	SHP 300	300X500	1,650	150,000	112,500	360	23.00	10,500
	SHP 400	400X500	1,875	200,000	266,667	480	26.00	17,500
	SHP 500	500X500	2,075	250,000	520,833	600	30.00	25,000
	UHP 250	250x1,000	2,800	137,100	45,350	343	10.00	5,500
	UHP 350	350x1,000	3,160	177,020	115,926	443	15.00	16,000
	UHP 450	450x1,000	3,560	202,020	263,988	505	17.00	30,000

4. PRESTRESSED CORRUGATED CONCRETE SHEET PILE



TPC corrugated concrete sheet pile is produced under quality control and up-to-date machine. All processes of the production are strongly concentrated by the engineers and supervisors. Our products are well-known used for the permanent and also temporary retaining wall. Our innovative design is more suitable safe, and economy when compare with general steel sheet pile. TPC corrugated concrete sheet piles can be designed for all construction cases and the construction sequence required.

To select the cross-sectional area, length, the bending moment and the shear force, TPC corrugated concrete sheet pile must be designed and calculated by only the specialized engineer. The design and method of construction must be considered and suggested to the contractors. Also the method of construction is strictly controlled by the civil engineer at site.



STANDARD SPECIFICATION

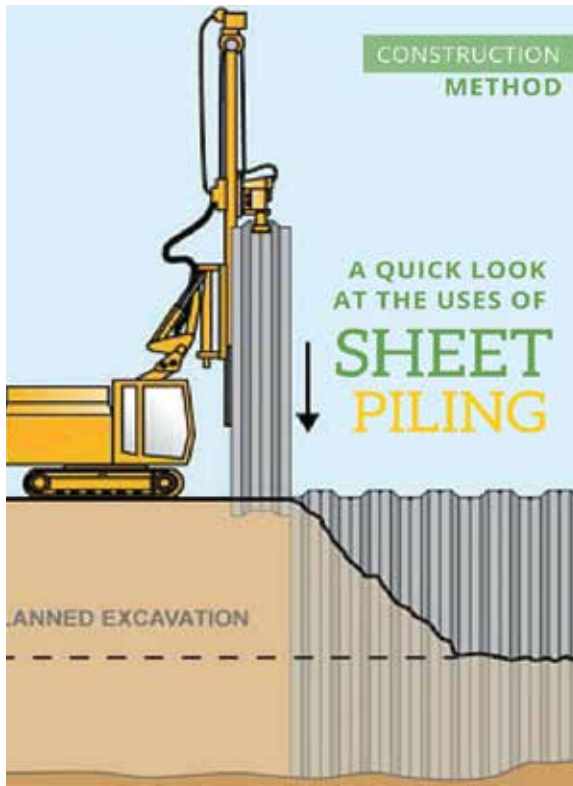

CONCRETE

- Minimum ultimate compressive strength shall not less than 500 ksc. cylinder at 28 days.
- Minimum transfer strength shall not less than 350 ksc. cylinder.
- High early strength Portland cement is used and cement content shall not less than 450 kgs. per cubic metre.

PC. STRAND

- PC.7-Wire-strand Ø3/8" and Ø1/2" (Grade 270k) are used and minimum breaking strength is about 16,500-18,500 ksc.
- Minimum force transfer to concrete shall not be less than 70% of breaking strength.

REMARKS

- Allowable bending moment and shear force depend on soil condition and external surcharge load.

Type Designation	Height MM	Thickness MM	Width MM	Cracking Moment T-M	Length (M)																						
					4	4.5	5	5.5	6	6.5	7	7.5	8	8.5	9	9.5	10	11	12	13	14	15	16	17	18	19	20
W-160-1000	160	80	996	1.92	●	●	●	●	●	●	●	●	●														
W-180-1000	180			2.95	●	●	●	●	●	●	●	●	●														
W-225-1000	225	100		4.02			●	●	●	●	●	●	●	●													
W-250-1000	250			5.73				●	●	●	●	●	●	●	●												
W-300-1000	300	110		9.06					●	●	●	●	●	●	●	●											
W-325-1000	325			12.7							●	●	●	●	●	●	●	●									
W-350-1000	350	120		16.1											●	●	●	●	●	●							
W-400-1000	400			22.3													●	●	●	●	●	●					
W-450-1000	450	29.4															●	●	●	●	●	●	●				
W-500-1000	500	37.7																●	●	●	●	●	●	●			
W-600-1000	600	55.4																	●	●	●	●	●	●	●	●	●

5. PRESTRESSED CONCRETE SOLID PLANK GIRDER

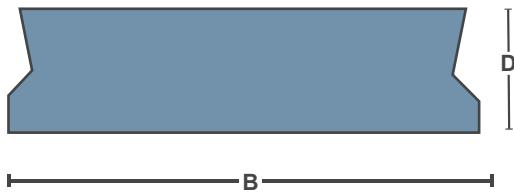

SPAN-M.	WEIGHT-KG.	DIMENSION-CM	
		B	D
5.00	1,920	100	16
6.00	2,740	100	19
7.00	3,700	100	22
8.00	4,800	100	25
9.00	6,700	100	31
10.00	8,400	100	35

STANDARD SPECIFICATION

CONCRETE

- Minimum ultimate compressive strength shall not less than 350 ksc. cylinder at 28 days.
- Minimum transfer strength shall not less than 245 ksc. cylinder.
- High early strength Portland cement is used and cement content shall not less than 350 kgs. per cubic metre.

PC. WIRE

- PC. 7-Wire strand $\emptyset 3/8"$, $\emptyset 1/2"$ (Grade 270 k) are used and minimum breaking strength is about 18,500 ksc.
- Minimum force transfer to concrete shall not be less than 70% of breaking strength.



6. PRESTRESSED CONCRETE I - GIRDER

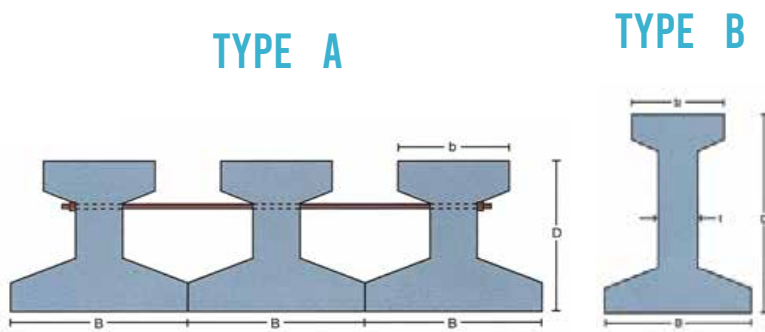

STANDARD SPECIFICATION

CONCRETE

- Minimum ultimate compressive strength shall not less than 350 ksc. cylinder at 28 days.
- Minimum transfer strength shall not less than 245 ksc. cylinder.
- High early strength Portland cement is used and cement content shall not less than 350 kgs. per cubic metre.

PC. WIRE

- PC.7-Wire strand $\varnothing 3/8"$, $\varnothing 1/2"$ (Grade 270 k) are used and minimum breaking strength is about 18,500 ksc.
- Minimum force transfer to concrete shall not be less than 70% of breaking strength.

TYPE	SPAN - M.	WEIGHT - KG.	DIMENSION - CM.			
			b	B	D	t
A	5.00	600	20	33	34	8
A	6.00	720	20	33	34	8
A	7.00	1,040	20	33	34	8
A	8.00	1,190	20	33	34	8
A	9.00	1,500	20	33	42	8
A	10.00	1,670	20	33	42	10
B	9.00 - 14.00	4,100 - 6,500	30	40	70	15
B	12.00 - 18.00	7,000 - 10,500	30	45	90	15
B	16.00 - 24.00	14,000 - 21,000	40	50	115	18
B	21.00 - 30.00	26,000 - 37,000	50	65	135	20



7. PRESTRESSED CONCRETE BOX GIRDER

TYPE A

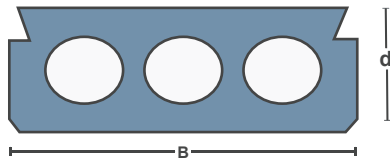

TYPE B

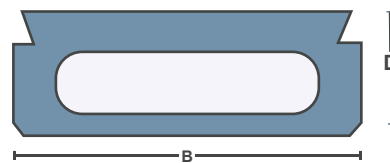

STANDARD SPECIFICATION



TYPE	SPAN - M.	WEIGHT - KG.	DIMENSION - CM.		
			B	D	d
A	5.00	3,000	100	-	30
A	6.00	3,450	100	-	30
A	8.00	5,750	100	-	40
A	10.00	7,050	100	-	40
A	12.00	11,000	100	-	50
B	14.00	12,000	100	60	-
B	16.00	15,800	100	70	-
B	20.00	19,500	100	70	-
B	25.00	26,000	100	85	-
B	30.00	34,000	100	100	-

- CONCRETE**
- Minimum ultimate compressive strength shall not less than 350 ksc. cylinder at 28 days.
 - Minimum transfer strength shall not less than 245 ksc. cylinder.
 - High early strength Portland cement is used and cement content shall not less than 350 kgs. per cubic metre.

- PC. WIRE**
- PC. 7-Wire strand $\varnothing 3/8"$, $\varnothing 1/2"$ (Grade 270 k) are used and minimum breaking strength is about 18,500 ksc.
 - Minimum force transfer to concrete shall not be less than 70% of breaking strength.



8. PRESTRESSED CONCRETE PEDESTRAIN BRIDGE T GIRDER

STANDARD SPECIFICATION

- CONCRETE**
- Minimum ultimate compressive strength shall not less than 350 ksc. cylinder at 28 days.
 - Minimum transfer strength shall not less than 245 ksc. cylinder.
 - High early strength Portland cement is used and cement content shall not less than 350 kgs. per cubic metre.
- PC. WIRE**
- PC. 7-Wire strand $\varnothing 3/8"$, $\varnothing 1/2"$ (Grade 270 k) are used and minimum breaking strength is about 18,500 ksc.
 - Minimum force transfer to concrete shall not be less than 70% of breaking strength.



TYPE	TYPE	SPAN-M.	WEIGHT-KG.	DIMENSION-CM.					
				A	B	C	D	E	F
	1	35.26-37.75	55,000-59,000	150	15	13	15	50	25
	2	32.76-35.25	50,000-55,000	150	15	13	15	50	25
	3	30.26-32.75	40,500-44,000	130	15	12	15	45	22
	4	27.76-30.25	34,000-40,000	130	15	12	15	45	22
	5	25.26-27.75	31,000-33,000	110	12	10	12	40	20
	6	22.76-25.25	27,000-29,500	110	12	10	12	40	20
	7	20.26-22.75	23,000-25,500	100	12	6	12	30	18



10. PRECAST WHEEL STOP

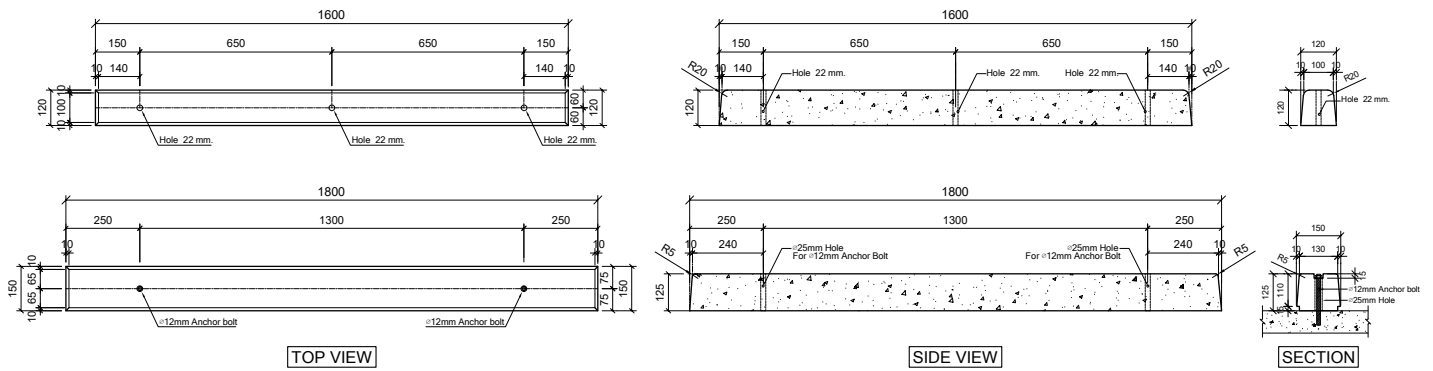

CODE	TYPE	DIMENSION IN MILLIMETRE			WEIGHT
		WIDTH	HIGHT	LENGTH	KG.
WS 120/600	RC. PRECAST WHEEL STOP	120	120	600	21
WS 120/1600	RC. PRECAST WHEEL STOP	120	120	1600	55
WS 120/2000	RC. PRECAST WHEEL STOP	120	120	2000	69
WS 150/1800	RC. PRECAST WHEEL STOP	150	125	1800	81



11. PRECAST CONCRETE FACADE

In the developed countries, most buildings are suitable for construction in precast concrete. To avoid many problems on site such as the skill labours shortage, the materials wastage and the time loss during construction, the precast concrete facade panel is one of concrete elements to speed of construction and to control of quality.

The advantages in using the precast concrete facade are as follows ;

1. Better standard size due to the pre-designation and the production from the standardized and controlled factory.
2. Better standard quality and durability due to the high early strength of concrete. Ensure that more compressive strength and shrinkage reducing we can get and furthermore minimum 50 years long life.
3. Speed of construction is a major consideration. The reason is not only in fast erection, but also in the fact that whilst the foundation works are carried out on site, the precast concrete facade are manufactured at the factory at the same time.
4. Optimum cost due to the materials wastage in the simple brick wall and no costing for external plastering work.
5. Precast concrete facade offers a wide range of top quality finished in a panoply of colors and textures.

Many of the medium or huge buildings such as condominium, apartment, housing, department store and factorie are therefore well-known in using the precast concrete facade.



STANDARD SPECIFICATION



CONCRETE

- Minimum ultimate compressive strength shall not less than 280 ksc. cylinder at 28 days.
- High early strength Portland cement is used and cement content shall not less than 300 kgs. per cubic metre.



REINFORCEMENT

- Using the Round bars in class SR24
- Using the Deformed bars in class SD40
- Using the Cold drawn bars in class FY 5500

REMARKS

- The thickness, the sizing, the reinforcement and embedded steel plate are designed by only the expert engineers.



12. GLASS REINFORCED CONCRETE



Glass Reinforced Concrete (GRC) is a composite material consisting of a portland cement and sand mortar, reinforced with alkali-resistant glass fibres. The GRC may contain additional filler materials and admixtures. The final properties of GRC depend on a wide range of variables such as mix materials and formulation, manufacture, fibre product type, length & orientation and admixtures used.

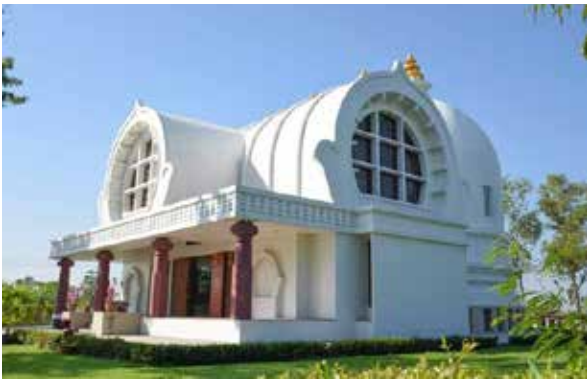

GRC is a composite material which combines the high compressive strength properties of cement mortars with significantly increased impact, flexural and tensile strength imparted by the fibre reinforcement. GRC does not contain asbestos, has good chemical resistance and will not rot or corrode. GRC is made of inorganic materials and will not burn, has negligible smoke emission and offers good fire resistance. Products of

relatively thin cross section can be made, giving a low component weight which may allow savings in handling, storage, transportation, installation and in the supporting building frame.

The potential for the use of glass reinforced concrete systems was recognised during the early development work on glass fibre reinforced plastics carried out in the 1940s. Following the successful development of AR (alkali resistant) glass fibres in the late 1960s, test programmes were undertaken to determine the properties of portland cement and AR glass fibre composites. GRC is also used for furniture, cladding and as permanent formwork.



Typical products made using the spray process include architectural cladding panels, agricultural components, tanks, facade elements, ducting and formwork.

GRC panels, through the application of finish shape, color, or texture, contribute to the architectural form and finished effect of a structure's facade. Design flexibility in surface appearance is possible by incorporating various cements, coarse aggregates, sands, and pigments into the face mix. Natural stone products may be used as a veneer finish if special design requirements are met. Alternatively, panels may be painted or stained to achieve the required colors.



MATERIALS :

1. Portland cement type 1
2. Silica sand with fine gradation and silica content > 96%
3. Glass fiber with alkali resistant type and at least 16% zirconia content
4. Clean water with no pH
5. Admixtures such as polymers, superplasticizers and color pigments



PHYSICAL PROPERTIES :

1. Compressive strength 500 - 800 ksc.
2. Tensile strength 80 - 120 ksc.
3. Flexural strength 180 - 300 ksc.
4. Punching shear strength 250 - 350 ksc.
5. In-plane shear strength 70 - 120 ksc.
6. Interlaminar shear strength 20 - 40 ksc.
7. Dry bulk density 1.8 - 2.1 ton/m³
8. Water absorption 8 - 13 %
9. Apparent porosity 16 - 25 %
10. Fire resistant up to 4 hours.

REFERENCE :

The International Glass Fiber Reinforced Concrete Association, UK.

13. TPC KOOL WALL



Usually the structural of Dome is nearly similar to the structural of Shell which can resist the actual force more than the structural of Plain structure. The actual force occurred can distribute over all the structure. Therefore, Dome structure is thin when compared with the general structure. Less concrete and less reinforcement which are the advantages of Dome structure make the most satisfy to the architecture and the design engineer.

To construct the Dome structure following the Architector and the Design Engineer is not so easy due to the curve and bend formwork. Shoring the curve and bend formwork is difficult in practical and makes high cost and time loss. TPC KOOL WALL is well-known used by the Architector and Design Engineer in using this kind of material to update the new technology.



STANDARD SPECIFICATION



CONCRETE

- Minimum ultimate compressive strength shall not less than 280 ksc. cylinder at 28 days.
- High early strength Portland cement is used and cement content shall not less than 300 kgs. per cubic metre.

REINFORCEMENT

- Using the Round bars in class SR24.
- Using the Deformed bars in class SD40.
- Using the Cold drawn bars in class FY5500.

EPS

- EPS : Expanded Polystyrene Foam is used for weight reducing and for adjust the shape according to the architectural design.

REMARKS

- The thickness, reinforcement and size of EPS are strictly controlled by only the design engineer.



14. PRECAST CONCRETE FORMWORK



In the develop countries most buildings are suitable for conventional method of construction. One factor to enable the good quality to the construction is formwork method.

Generally the steel formwork and timber formwork are mostly used in the construction anyhow if they are not designed and installed by the engineers or the specialists, may cause the defect work & time loss due to unstrongly formwork and/or mis-shoring.

With the various reasons nowadays the main contractors mostly prefer to use the Precast concrete Formwork instead of the steel and timber formwork for foundation & ground beam.

The advantages in using the Precast concrete Formwork are as follows ;

1. Better standard size due to the pre-designation and the production from the standardized and controlled factory.
2. Better standard quality and durability due to the high early strength concrete, therefore they can resist the bending & shear force better than normal grade concrete.
3. Speed of construction is a major construction. Using the precast concrete formwork we can go forward no need to wait for the demoulding.
4. Optimum cost due to the materials wastage in the method of steel formwork or timber formwork. Many of the medium or huge buildings such as condominium, apartment, housing, department store and factory are therefore well known in using the precast concrete formwork.

STANDARD SPECIFICATION

CONCRETE

- Minimum ultimate compressive strength shall not less than 350 ksc. cylinder at 28 days.
- Minimum transfer strength shall not less than 245 ksc. cylinder.
- High early strength Portland cement is used and cement content shall not less than 350 kgs. per cubic metre.



PC. STRAND

- PC.Wire \varnothing 4, 5 mm. and 7-Wire-strand \varnothing 3/8" and \varnothing 1/2" (Grade 270k) are used and minimum breaking strength is about 16,500-18,500 ksc.
- Minimum force transfer to concrete shall not be less than 70% of breaking strength.

REMARKS

- Allowable bending moment and shear force depend on soil condition and external surcharge load.

STANDARD SECTION OF HOLLOW CORE WALL	THICKNESS (mm.)	MOMENT (Kg.-m.)	WEIGHT (Kg./m ²)	STANDARD SIZE	
				(T) Thick (mm.)	(W) Width (mm.)
	80	2,000	146	80	1200
	100	3,500	153	100	1200
	120	4,500	166	120	1200
	150	8,500	186	150	1200



15. PRECAST CONCRETE FENCE

TPC prestressed concrete fence is designed and produced for the general fencing work around the area of factory, warehouse, house and etc. The design is most suitable for rapid work, durable, strong and nice when compare with normal concrete block fencing. Due to prestressing concrete technique and double expose concrete surface in the production line enable TPC fence more attractive than the other brands.

The standard length, 3.00 m. and the standard height, 1.00 – 3.00 m. make easily ways in the site for architecture, engineer and project owner.

- Durable due to prestressed concrete technique.
- Standard quality under quality control and alternative design selected.
- More convenient because all elements are precast products such as pile, footing, post, wall and lintel.

TPC fence can be used as temporary fence and can be re-installed whenever we need to adjust.



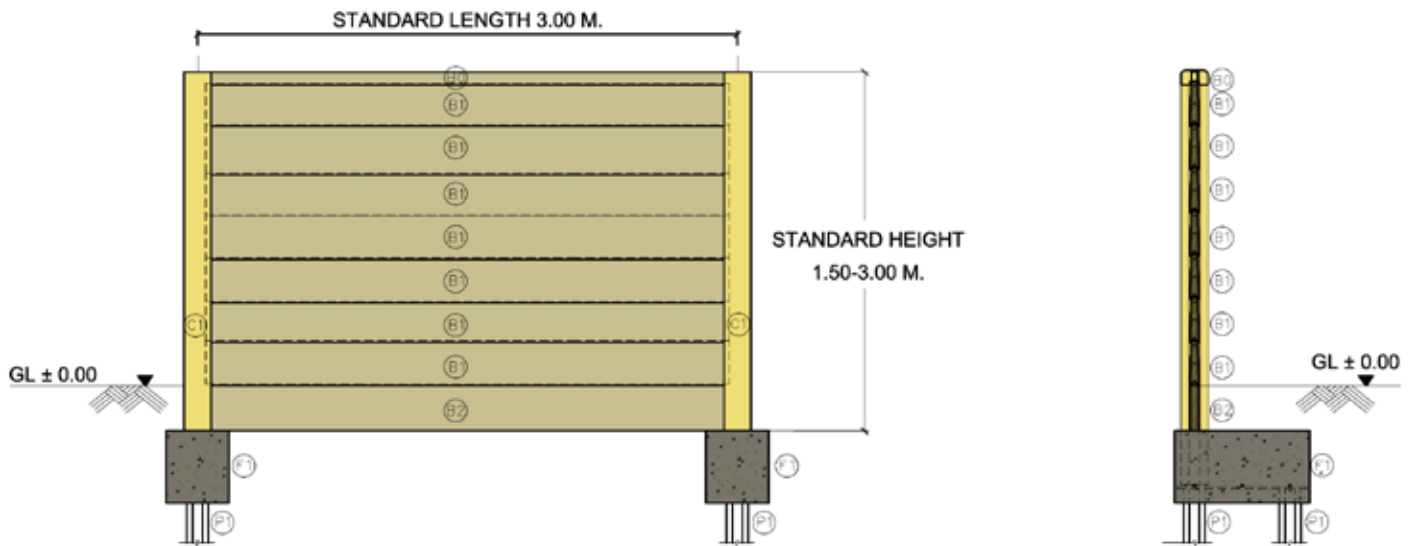

- | | | | | | |
|----|-----------------|----|-------------------|----|---|
| Ⓒ1 | PC FENCING POST | Ⓒ0 | PC LINTEL | Ⓕ1 | PC FOOTING |
| Ⓒ2 | CORNER POST | Ⓒ1 | PC WALL | Ⓕ1 | 2-I-PILE 0.12x0.12x4.00-6.00M.OR |
| Ⓒ3 | END POST | Ⓒ2 | PC RETAINING WALL | | 2-HEXA PILE Ø 0.15 ² x4.00-6.00M |

CONCRETE

- Minimum ultimate compressive strength shall not less than 350 ksc. cylinder at 28 days.
- Minimum transfer strength shall not less than 245 ksc. cylinder.
- High early strength Portland cement is used and cement content shall not less than 350 kgs. per cubic metre.

PC. WIRE

- Pc wire Ø 4,5 mm are used and minimum breaking strength is about 16,500-18,500 ksc.
- Minimum force transfer to concrete shall not be less than 70% of breaking strength.

FENCING SIZE IN METRE	2.0 X 3.0	2.25 X 3.0	2.5 X 3.0	3.0 X 3.0
NO. AND SIZE OF PILE TO BE USED	2 - 1 0.12 ² X 4.00	2 - 1 0.12 ² X 4.00	2 - 1 0.12 ² X 5.00	2 - 1 0.12 ² X 6.00
	2 - Ø 0.15 ² X 4.00	2 - Ø 0.15 ² X 4.00	2 - Ø 0.15 ² X 5.00	2 - Ø 0.15 ² X 6.00

TPC

TPC PRESTRESSED CONCRETE CO., LTD.

COMPANY ADDRESS

No. 8,7 Thuyen Road, Latphao, Bangkok 10230
Phone : 0-2944-6180
Fax : 0-2944-6181
Email : tpebkk@gmail.com
www.tpcconcrete.com

